



Auto Electrical Snail Horn

CHINT® Automotive is an automotive Horn manufacturer and supplier in China. We have been specialized in automotive Horn over twenty years. CHINT® automotive Horn mainly includes Auto Electrical Snail Horn, Disc Horn, Air Horn for OEM and Aftermarket; Have obtained CCC certificate of China and E-mark certificate. Be able to develop various

connectors, pins even horns as per your requirements and brand & packaging can be customizable as well.

	Auto Electrical Snail Horn	Product Specification Intro
		DLD161 Series
Description		
<p>CHINT® Auto Electrical Snail Horn is Electrical Horn, use the PCB and electronic unit to realize the function. By using the MOSFET instead of the traditional contact to increase the life endurance and ensure higher quality of sound.</p> <p>1> Good sound and SPL in various environment conditions (High&low temperature plateau area) due to the new technique of frequency control principle.</p> <p>2> More than 500,000 operations of the life endurance due to the MOSFET, 5 times more than the mechanical type Elec-Horn, and be able to sound continually more than 10 mins;</p> <p>3> IP67;</p> <p>Supply for: Mazda, ISUZU, GM. etc..</p>		
Electrical Specification	Application:	
Rated Working Voltage: 12V		
Rated Current: 5A		
Sharp Tone: 510±25Hz		
Deep Tone: 420±25Hz		
Sound Pressure Level (SPL): 105-118dB(A)		
Diameter: φ80mm		
Life Endurance: 500,000 cycles		
IP67		
Mounting Diagram:		

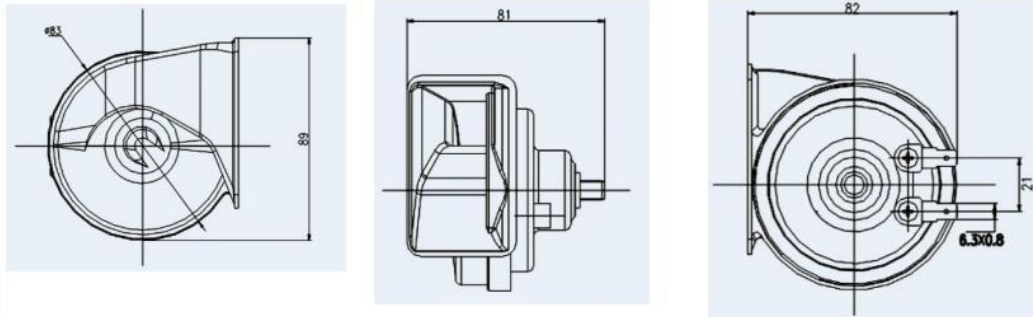





Ordering Information

Model	Elec-Spec.	Type	Sharp Tone	Deep Tone	SPL	Diameter
DLD161	12V,5A	Single/Double Tone	510±25HZ	420±25HZ	105-118dB(A)	Φ80MM

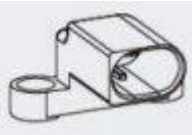
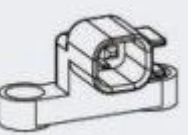
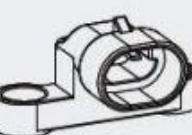
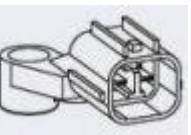
Connector:

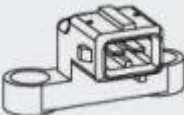
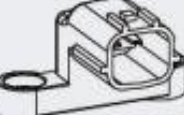
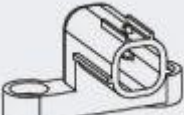

	<p>Audi: A8、A6L、A4、A3、A1、Q7、Q5、Q3、TT Porsche: Cayenne Panamera Macan 911 Volkswagen: Passat NMS、Passat CC、Bora、Santana.. Skoda: Superb、Octavia、Fabia</p>		<p>Ford: S-MAX、MUSTANG、FIESTA、Edge、EcoBoost Volvo: XC90、S80、S60 Landrover: Discovery 4、Range Rover Sport、Freelander 2 Jaguar: XF、XJ Lincoln: MKZ、MKC、MKX、Navigator</p>
	<p>Buick: Regal、LaCrosse、Encore、Park Avenue Chevrolet: Captiva、Cruze</p>		<p>GM: Epica/evanda</p>
	<p>Citroen: all series F.I.A.T.: all series</p>		<p>Hyundai: Accent、Sonata、Tucson、SantaFe、matrix、Azera、Centennial、Rohens、tiburon、Veracruz</p>

	<p>Peugeot: all series</p>		<p>Kia: All series</p>
	<p>Honda Acura: MDX、NXS</p>		<p>BMW: New BMW 5、 New BMW 7</p>
	<p>Dodge: Ram、 Caliber、Journey、300C MAZDA: M2、M3、M5、M6、 M8、MX-5、CX-5、CX-7 JEEP: Compass、Cherokee</p>		<p>BMW、MINI、Landrover</p>
	<p>Basic type</p>		